



# Comfort, Aesthetics and Reliability

## User Manual

**60 cm Ceramic Cooktop, Model Code: TRC604**

Please read this manual carefully before using, and keep it for future reference.

## INSTRUCTION MANUAL

### 60cm Ceramic Cooktop



### MODEL TRC604

#### **Congratulations on the purchase of your new Ceramic Hob!**

We recommend that you spend some time to read this Instruction / Installation Manual in order to fully understand how to install and operate it correctly. For installation, please read the installation section. Read all the safety instructions carefully before use and keep this Instruction / Installation Manual for future reference.

## CONTENTS

---

<b>1. PACKAGE</b> .....	4
1.1 IMPORTANT - CHECK FOR ANY DAMAGE OR MARKS.....	4
1.2 BEFORE USING YOUR NEW CERAMIC HOB.....	4
<b>2. SAFETY WARNINGS</b> .....	5
2.1 IMPORTANT INFORMATION.....	5
2.2 WARNING!.....	5
2.3 USAGE CONDITIONS AND RESTRICTIONS.....	5
<b>3. PRODUCT OVERVIEW</b> .....	8
3.1 TOP VIEW.....	8
3.2 CONTROL PANEL/USER INTERFACE.....	9
3.3 PRODUCT FUNCTIONS.....	10
<b>4. INSTALLATION</b> .....	11
4.1 SELECTION OF INSTALLATION EQUIPMENT.....	11
4.2 INSTALLATION.....	13
4.3 CAUTIONS.....	14
4.4 CONNECTING THE HOB TO THE MAIN POWER SUPPLY.....	15
<b>5. USING YOUR COOKTOP</b> .....	16
5.1 CHOOSING THE RIGHT COOKWARE.....	16
5.2 USING TOUCH CONTROLS.....	17
5.3 START OPERATION.....	17
5.4 CHILD LOCK FUNCTION.....	18
5.5 USING THE TIMER.....	18
5.6 Using The pause function: Stop & Go.....	19
5.7 Using the Keep Warm Function.....	19
<b>6. CARE AND MAINTENANCE</b> .....	20
6.1 CARE.....	20
6.2 APPLIANCE CLEANLINESS.....	21
<b>7. TROUBLESHOOTING</b> .....	22
<b>8. TECHNICAL SPECIFICATIONS</b> .....	23
<b>9. DISPOSAL</b> .....	23
<b>10. CUSTOMER CARE</b> .....	24

# 1. PACKAGE

When unpacking the appliance, please check that the following items are contained within the package:

- 1 Hob
- 1 Instruction manual
- 4 Fixing screws
- 4 Fixing brackets
- 1 Sealing strip

## 1.1 IMPORTANT - CHECK FOR ANY DAMAGE OR MARKS

Please thoroughly inspect your goods at the delivery time, if you notice any damage to your goods:

– please notify the delivery team at the time of delivery and DO NOT accept damaged product;

– please notify us immediately, as the problem can be solved, and damaged

product can be returned to the courier.

When you open the package and find the appliance is damaged or marked, you must report it **within 24 hours**. Do not install or connect the item and keep the package as it was originally if you wish to claim for damage/marks under the manufacturer's warranty. This does not affect your statutory rights.

Evidence of damage will be required.

## 1.2 BEFORE USING YOUR NEW CERAMIC HOB

- Read this guide, taking special note of the 'Safety Warnings' section.
- Remove any protective film that may still be on your ceramic hob.

## 2. SAFETY WARNINGS

### 2.1 IMPORTANT INFORMATION

Your safety is important to us. Please read this manual thoroughly before you start using the Ceramic Cooktop.

The safety precautions instructions reduce the risk of fire, electric shock and injury when correctly complied to.

Please follow all instructions and take notice of all warnings.

### 2.2 WARNING!

**INSTALLATION:** This Cooktop must be installed by a licensed electrician.

- Make sure to have this appliance connected to a well-placed earth wiring system. Before carrying out any work, repairs or maintenance on this appliance, it has to be disconnected from the mains. If possible, switch of the cooktop from the wall before cleaning, failure to do so may result in electric shock or death.
- During use be sure to avoid any direct contact with the surface as you may get burned. Always use this appliance with caution. Do not touch any components of the cooktop as it will be hot. It is highly recommended that you use cooktop gloves when handling cookware.
- Do not leave any items on the cooktop as this is a fire hazard. In the case of a fire do not use a fire extinguisher with water. It is highly recommended that you switch off the cooktop and cover the flames with a fire blanket.

### 2.3 USAGE CONDITIONS AND RESTRICTIONS

- Supervision over children is to ensure that they do not play with the appliance. Never allow them to use, play with or crawl inside the appliance.
- Cleaning and maintenance must not be done by children.
- This appliance is not to be used by persons (including children) with reduced physical, sensory or mental capabilities, or lack of experience and knowledge, unless under responsible supervision and instruction to ensure appliance hazards are understood.
- Make sure to read all rules and regulations in this manual. Anyone who is not familiar with this appliance is not to operate it. These instructions do not cover every possible situation or condition as with any appliance. Use extreme caution when installing, operating and maintaining this appliance.
- Never leave the cooktop unattended while in use.

- Only for indoor domestic use only. It is not to be used for industrial or commercial use.
- Do not use this product for anything other than its intended purpose, and only use it as described in this manual. Do not attempt to alter or modify this appliance.
- This appliance can become extremely hot and therefore children and pets are to be kept away. If younger family members are in the kitchen, be sure to keep close supervision at all times. Do not allow children to operate or play with this appliance.
- Do not use the cooktop for heating up the area.
- Make sure you do not use the appliance if any part has been damaged. It must only be repaired by a qualified technician. Incorrect repair could expose you to risk of electric shock, fire or injury. If you continue to use the product in such condition it could cause fire or electrocution.
- The appliance is not intended to be operated by means of an external timer or separate remote-control system.
- Do not store items on the cooking surfaces
- Caution: The cooking process has to be supervised; a short-term cooking process has to be supervised continuously.
- Warning: Unattended cooking on a hob with fat or oil can be dangerous and may result in a fire.
- Do not use any unstable or plastic cookware products or aluminium foil containers. No large cookware is to overlap bench as this can deflect heat back onto the cooktop and damage the surface. Cookware products can become hot while in use with this appliance. Be sure to position handles away from reach of children.
- Make sure not to switch on hotplate without anything on it, do not use cooktop to warm up plates.
- Do not place anything heavier than 20kgs on the cooktop.
- Checking constantly when frying food to ensure that oil is not overheating and becomes a fire hazard. Do not overfill deep fry pans with oil (more than one third) and be sure not to leave unattended.
- Make sure to switch off all controls when not in use and allow surface to cool before cleaning.
- If accessible, disconnect the appliance from the mains before cleaning.
- Do not cover the appliance or power cord in water or other liquids.
- Do not use any steam cleaning products for the cleaning of this appliance.
- Do not disconnect the appliance by using wet hands, gripping end of plug or forcefully pulling cord to disconnect. Grip end of plug, and do not pull cord to disconnect.
- Do not use appliance if there is a technical fault. All faults must be fixed by a qualified/authorised person.
- Incorrect use can result in property damage, injury or death. We assume no liability for misuse of the appliance or noncompliance with these instructions.
- WARNING! If the surface cracks, switch of the appliance immediately to avoid the possibility of electric shock and call our customer support.

- Be careful when using this cooktop, as the cooktop complies with all safety regulations, we do not wish for customers to burn themselves as the surface will become extremely hot during use and will retain heat after use.
- Please remember to allow for the cooktop to cooldown before attempting to clean.
- Young children should be kept away from this appliance at all times! Take extreme caution when using the appliance to ensure they do not come anywhere close the cooktop.
- Do not leave any items on top of the cooktop as these can become a fire hazard.
- This appliance is not intended to be operated by means of an external timer or separated remote control system.

## 3. PRODUCT OVERVIEW

### 3.1 TOP VIEW

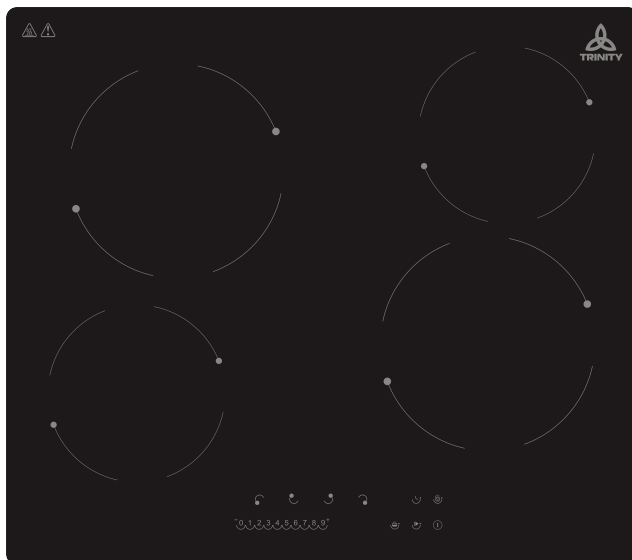









#### Heating Zone Power

Heating Zone	Max. Power (220-240V~50/60Hz)
	1200W(230V~)
	1800W(230V~)
	1200W(230V~)
	1800W(230V~)
Total Rating Power	6000W(230V~)



### 3.2 CONTROL PANEL/USER INTERFACE



Reference	Description
A 	Zone select key
B 	ON/OFF key
C 	Power Regulating Key(Level 0~9)
D 	Timer regulating key (reduce)
E 	Timer regulating key (increase)
F 	Child lock key
G 	Timer key
H 	Keep warm key
I 	pause key

### 3.3 PRODUCT FUNCTIONS

The ceramic hob caters for all kinds of cooking with its radiant heat cooking zones, electronic touch controls, and multiple functions making it the ideal choice for the modern family. The ceramic hob is extremely user-friendly, durable and safe.

#### Special Functions

##### ✓ Protection from over-heating

A sensor monitors the temperature in the cooking zones. When the temperature exceeds the safe level, the cooking zone is automatically switched off.

##### ✓ Residual heat indicator

When the hob has been operating for some time, there will be some residual heat. The letter "H" appears to warn you that it is too hot to touch the surface.

##### ✓ Auto shutdown protection

Auto shutdown is a safety protection function for your ceramic hob. It shuts down automatically if you ever forget to turn it off. The default working times for various power levels are shown in the table below:

Power level	1~2	3~4	5	6~9
Default working timer (min)	360	300	240	90

##### ✓ Protection against unintended operation

If the electronic control detects a button being held down for approximately 10 seconds, the controller sends an audible error signal, warning the sensor to detect the presence of the object and displays the error code "ER03". It will shut down automatically. When the object is removed, it will stop displaying and buzzing and can then be rebooted.



Before using your New Ceramic Hob:

Read this guide, taking special note of the 'Safety Warnings' section.  
Remove any protective film that may still be on your Ceramic hob.

## 4. INSTALLATION

### 4.1 SELECTION OF INSTALLATION EQUIPMENT

Cut out the work surface according to the sizes shown in the drawing. For the purpose of installation and use, a minimum of 5 cm space shall be preserved around the hole.

Be sure the thickness of the work surface is at least 30 mm. Please select heat-resistant work surface material to avoid larger deformation caused by the heat radiation from the hotplate. As shown below:

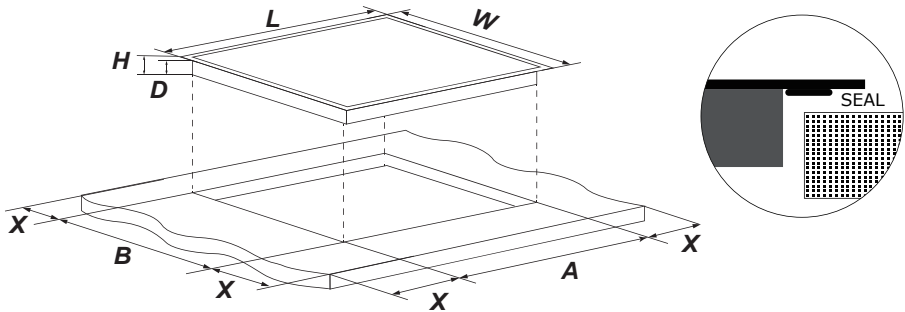

L (mm)	W (mm)	H (mm)	D (mm)	A (mm)	B (mm)	X (mm)
590	520	47	43	560	490	50 minimum

Under any circumstances, make sure the ceramic cooker hob is well ventilated and the air inlet and outlet are not blocked. Ensure the ceramic cooker hob is in a good work state. As shown below:



Note: The safety distance between the hotplate and the cupboard above the hotplate should be at least 650 mm.

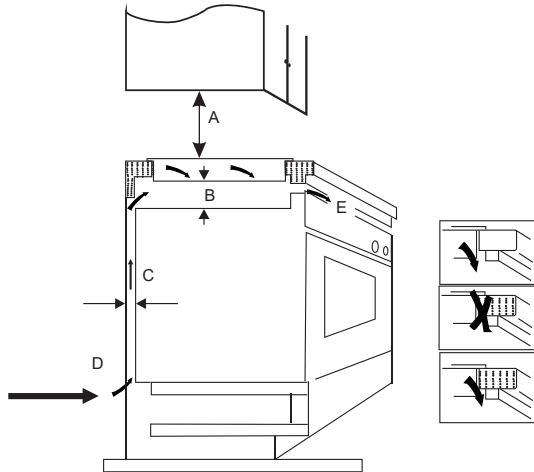

A (mm)	B (mm)	C (mm)	D	E
650	50 minimum	20 minimum	Air intake	Air exit 5 mm

### Before you install the hob, make sure that:

- ✓ the work surface is square and level and no structural members interfere with the space requirements;
- ✓ the work surface is made of a heat-resistant material;
- ✓ if the hob is installed above an oven, the oven has a built-in cooling fan;
- ✓ the installation will comply with all clearance requirements and applicable standards and regulations;
- ✓ a suitable isolating switch providing full disconnection from the main power supply is incorporated in the permanent wiring, mounted and positioned to comply with the local wiring rules and regulations. The isolation switch must be of an approved type and provide a 3 mm air gap contact separation in all poles (or in all active [phase] conductors if the local wiring rules allow for this variation of the requirements);
- ✓ the isolating switch will be easily accessible to the customer with the hob installed;
- ✓ you consult with the local building authorities and by-laws if in doubt regarding the installation;
- ✓ you use heat-resistant and easy-to-clean finishes (such as ceramic tiles) for the wall surfaces surrounding the hob.

### When you have installed the hob, make sure that:

- ✓ the power supply cable is not accessible through cupboard doors or drawers;
- ✓ there is adequate flow of fresh air from outside the cabinetry to the base of the hob;
- ✓ if the hob is installed above a drawer or cupboard space, a thermal protection barrier is installed below the base of the hob;
- ✓ the isolating switch is easily accessible.

## 4.2 INSTALLATION

fig.1

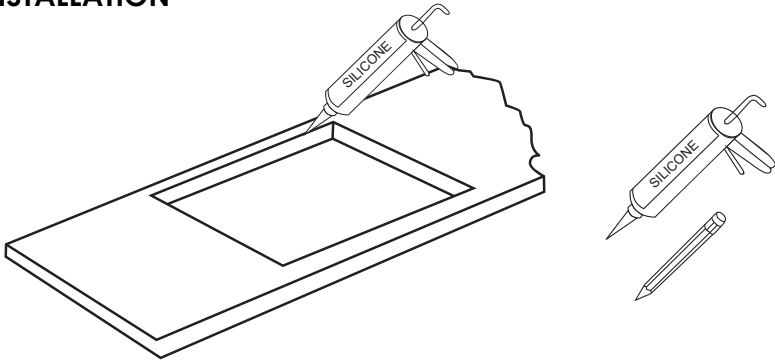

Cut out worktop to supplied dimensions shown (fig.1) with suitable equipment. Seal the cut edge of the worktop using silicone PTFE and allow to dry prior to fitting the hob.

fig.2

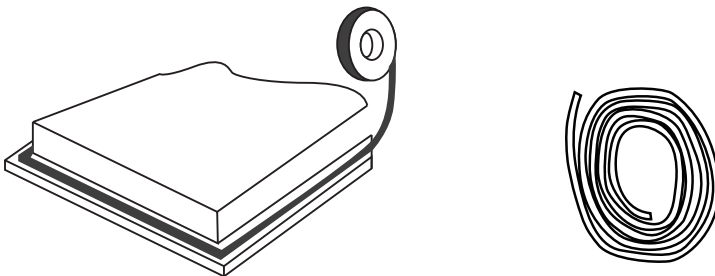

Stretch out the supplied seal along the underside edge of the hob, ensuring the ends overlap.

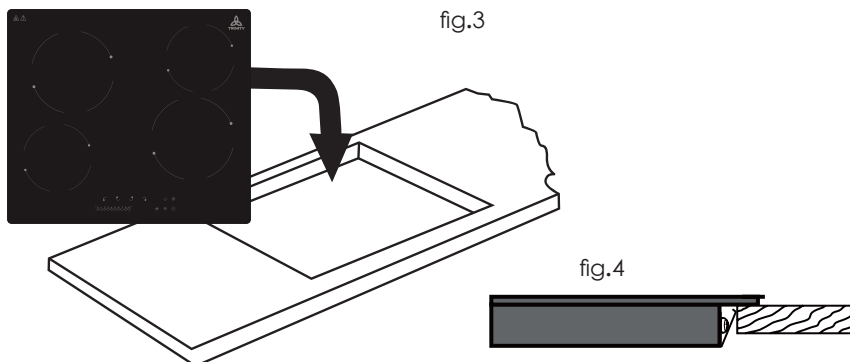

Do not use adhesive to fix the hob into the worktop. Once the seal is fitted position the hob into the cutout in the worktop. Apply gentle downwards pressure onto the hob to push it into the worktop ensuring a good seal around the outer edge (fig. 4)

### 4.3 CAUTIONS

1. The ceramic cooker hob must be installed by qualified personnel or technicians. We have professionals at your service. Please never conduct the operation by yourself.
2. The ceramic cooker hob must not be mounted to cooling equipment, dishwashers and rotary dryers.
3. The ceramic cooker hob must be installed in a way for better heat radiation in order to ensure and enhance its reliability.
4. The wall and induced heating zone above the work surface shall withstand heat.
5. To avoid any damage, the sandwich layer and adhesive must be resistant to heat.
6. A steam cleaner is not to be used.
7. This ceramic hob can be connected only to a supply with system impedance no more than 0.427 ohm. In case if necessary, please consult your supply authority for system impedance information.

### 4.4 CONNECTING THE HOB TO THE MAIN POWER SUPPLY

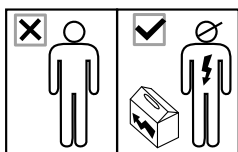

All installation work must be carried out by a competent person or qualified electrician. Before connecting the main supply, ensure that the mains voltage corresponds to the voltage on the rating plate inside the cooker hood.

## Warning: THIS APPLIANCE MUST BE EARTHED.



This hob must be connected to the mains power supply only by a suitably qualified person. Before connecting the hob to the mains power supply, check that:

1. The domestic wiring system is suitable for the power drawn by the hob.
2. The voltage corresponds to the value given in the rating plate.
3. The power supply cable sections can withstand the load specified on the rating plate.

To connect the hob to the mains power supply, do not use adapters, reducers, or branching devices, as they can cause overheating and fire.

The power supply cable must not touch any hot parts and must be positioned so that its temperature will not exceed 75°C at any point.



Check with an electrician whether the domestic wiring system is suitable without alterations. Any alterations must only be made by a qualified electrician.

This appliance is supplied with 3 core mains cables coloured as follows:

Brown = L or Live

Blue = N or Neutral

Green and Yellow = E or  Earth

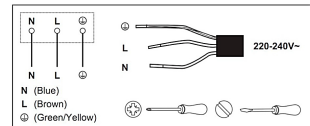

### This appliance requires a 32 Amp Miniature Circuit Breaker.

#### IMPORTANT:

- If the cable is damaged or needs replacing, the operation must be carried out by the after-sale agent with dedicated tools to avoid any accidents.
- If the appliance is being connected directly to the mains supply, an omni polar circuit breaker must be installed with a minimum gap of 3 mm between the contacts.
- The installer must ensure that the correct electrical connection has been made and that it complies with safety regulations.
- The cable must not be bent or compressed.
- The cable must be checked regularly and replaced by authorised technicians only.

## 5. USING YOUR COOKTOP

### Before using your new Ceramic Hob

- Read this guide taking special note of the "Safety Warnings" section.
- Remove any protective film that may still be on your Ceramic Hob.

## 5.1 CHOOSING THE RIGHT COOKWARE

Do not use cookware with jagged edges or a curved base.



Make sure that the base of your pan is smooth, sits flat against the glass, and is the same size as the cooking zone. Use pans whose diameter is as large as the graphic of the zone selected. Using a pot a slightly wider energy will be used at its maximum efficiency. If you use smaller pot efficiency could be less than expected. Always centre your pan on the cooking zone.

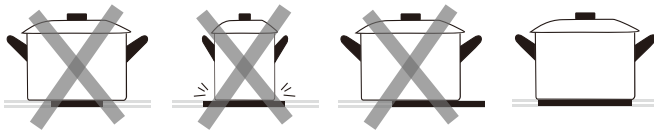

Always lift pans off the ceramic hob – do not slide, or they may scratch the glass.

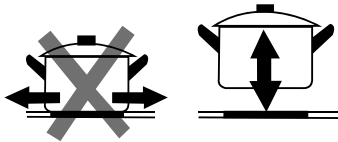

## Touch Controls

- The controls respond to touch, so you don't need to apply any pressure.
- Use the ball of your finger, not the tip.
- You will hear a "beep" buzzer sound each time a touch is registered.
- Make sure the controls are always clean, dry, and that there is no object (e.g. a utensil or a cloth) covering them. Even a thin film of water may make the controls difficult to operate.

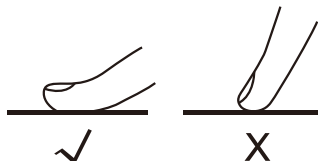



)" · G5FHCD9F5HCB

Ht'gUfhWtc\_b[

1. Place a suitable pan on the cooking zone that you wish to use. Make sure the bottom of the pan and the surface of the cooking zone is clean and dry.

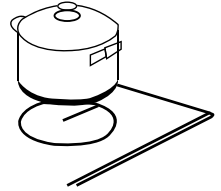

2. Touch the ON/OFF key for 2 seconds. After power is on, the buzzer beeps once, all displays show "0" indicating that the ceramic hob has entered the state of standby mode.

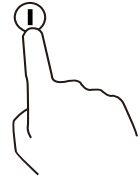

3. According to the heating zone where the pan is placed, press a relevant zone selection key (A). The symbol 0 will be flashing.

4. Select the power level by pressing the key  $9^+$  or key  $0^-$

5. The power level will start at 0. Pressing the "+" will count up the power levels from 0 to 9 in numerical order. Pressing the "-" key will take the power straight from 9 to 0.

- If you do not choose a heat setting within 20 seconds, the ceramic hob will automatically switch off. You will need to start again at step 2.
- You can modify the heat setting at any time during cooking.

## 5.4 CHILD LOCK FUNCTION

- You can lock the controls to prevent unintended use (for example children accidentally turning the cooking zones on).
- When the controls are locked, all the controls except the ON/OFF control are disabled.

## To lock the controls

Simultaneously press the key  for 3 seconds. The indicator will show "Lo".





## To unlock the controls

1. Make sure the hob is turned on.
2. Simultaneously press the key  for a while.
3. You can now start using your ceramic hob.



When the hob is in the lock mode, all the controls are disabled, except the ON/OFF. You can always turn the ceramic hob off with the ON/OFF control in an emergency, but you shall unlock the hob first in the next operation





## 5.5 USING THE TIMER

- You can set it to turn one cooking zone off after the set time is up.
  - You can set the timer for up to 99 minutes.
1. Select the relevant cooking zone by touching the zone selection key (A).
  2. Simultaneously press the "" key and the "" key, on the right side of two indicators will show "00"
  3. Using the "" or "" buttons, you can realize the setting of timing from 1 to 15 minutes.
  4. When the time is set, it will begin to count down immediately. The indicator will return to show power level after 5 seconds. The red dot next to power level indicator will illuminate indicating that the zone has set timer. 
  5. If you need to check the remaining time, you can repeat step 1 and step 2 again.
  6. When the cooking timer expires, the corresponding cooking zone will be switched off automatically. Other cooking zones will keep operating if they were turned on previously.

The timer function only work when at least one cooking is turned on. If you do not select any zone and touch the timer(G) directly to active the timer function,it only work as a Minute Minder.Buzzer will only bips for seconds and the timer indicator will turn off when the setting time finished,but cooking zones will not be switch off and still working .

## 5.6 Using The pause function: Stop & Go

The pause function can be used at any time during cooking. Allows Stop the hob and restore cooking without losing any adjustments.

- Make Sure the cooking zone is running.
- Press the Stop & Go  button. The Cooking zone indicators will show “= “. The hob Will Be deactivated, except for the Stop & Go , ON/OFF and Safe  .
- To Cancel the pause, press the Stop & Go  button. The Cooking Zones will return to the power level you previously set.

## 5.7 Using the Keep Warm Function

- > When using keep warm function, all previous multi-ring setting will be recognized automatically.
- > Touch the cooking zone selection button that you wish to use keep warm.
- > Touch key “☺” and the cooking zone indicator will show below icon:
  1. Showing "A" "b" "c" alternatively, which means the selected heating zone is under level A / b / c warm keeping and with only inner ring is on.
  2. Showing" A=" "b=" "c=" " alternatively, which means the selected heating zone is under level A / b / c warm keeping and with both middle and inner ring is on.
  3. Showing "A=" "b=" "c=" " alternatively, which means the selected heating zone is under level A / b / c warm keeping and with all rings working.

## 6. CARE AND MAINTENANCE



### Warning!

Always switch off the electricity supply before performing maintenance work. In the event of a fault, contact customer service.

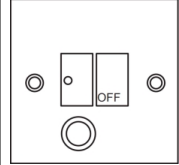

### 6.1 CARE



DAMAGED POWER CABLES SHOULD BE REPLACED BY A COMPETENT PERSON OR QUALIFIED ELECTRICIAN.



FOR DOMESTIC USE ONLY.



NEVER PLACE AN EMPTY PAN ON THE HOB AS THIS WILL CAUSE AN ERROR MESSAGE TO APPEAR ON THE CONTROL PANEL.



WHEN A COOKING ZONE HAS BEEN ON FOR A LONG TIME, THE SURFACE REMAINS HOT FOR SOME TIME AFTERWARDS SO, DO NOT TOUCH THE CERAMIC SURFACE.



FOR SEALED FOODS, PLEASE DO NOT HEAT THEM BEFORE OPENING REMOVING THE LID SO AS TO AVOID ANY DANGERS OF EXPLOSION DUE TO HEATING EXPANSION.



IF THE SURFACE OF THE HOB IS CRACKED, DISCONNECT FROM POWER SUPPLY TO AVOID ANY POSSIBILITY OF ELECTRIC SHOCKS.



DO NOT PLACE ROUGH OR UNEVEN PANS ON THE HOB, AS THEY COULD DAMAGE THE CERAMIC SURFACE.



AVOID BANGING POTS AND PANS DOWN ON THE HOB. THE CERAMIC SURFACE IS TOUGH BUT NOT UNBREAKABLE.



DO NOT PUT DETERGENTS OR FLAMMABLE MATERIALS BENEATH THE HOB.

## 6.2 APPLIANCE CLEANLINESS

### Caution

- Avoid rubbing with any abrasive or with the base of the pans, etc., as this will wear the markings on the top of the ceramic hob over time.
- Clean the ceramic hob on a regular basis to prevent the build-up of food residue.

The appliance should be cleaned after use.

The surface of the ceramic hob may be easily cleaned in the following way:

Type of dirt	Cleaning method	Cleaning materials
Lime scale	Apply white vinegar to the surface, then wipe it dry with soft cloth	Special ceramic cleaner
Burnt-on stains	Clean with damp cloth and dry it with a soft cloth	Special ceramic cleaner
Light stains	Clean with damp cloth and dry it with a soft cloth	Cleaning sponge
Melted plastics	Use a scraper suitable for ceramic glass to remove residue	Special ceramic cleaner

Use a scraper to immediately remove any aluminium foil bits, food spills, grease splashes, sugar marks and other high sugar content food from the surface in order to avoid damaging the hob. Subsequently, clean the surface with towel and appropriate product and proceed to rinse with water and dry with a clean cloth. Under no circumstance should sponges or abrasive cloths be used; also avoid using aggressive chemical detergents such as oven sprays and spot removers.

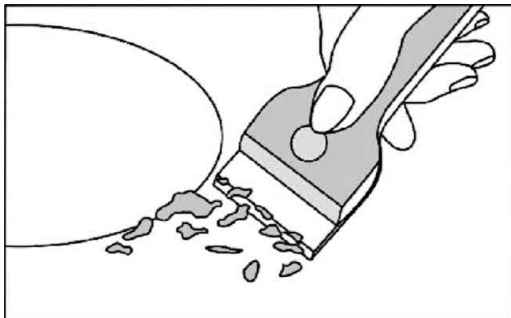

## 7. TROUBLESHOOTING

Before calling the customer services, please check that the appliance is correctly connected, any of the following cases are not covered by the warranty:

- Damage caused by improper use, storage or maintenance
- Damage caused by unauthorised disassembly and repair
- Damage caused by misuse.
- Using the ceramic hob for commercial purposes.

If an abnormality occurs, the ceramic hob will enter the protective state automatically and display corresponding protective codes:

Error Message	Possible Cause	What to do
<b>ER03</b>	Water or pot on the glass over the control	Clean the user interface
<b>E</b>	The thermocouple was loose or broken	Please contact the supplier to reconnect the thermocouple.
<b>ER21</b>	The temperature inside the produce was too high.	The produce must be stopped and cooling.

The above are the judgment and inspection of common failures.

Please do not disassemble the unit by yourself to avoid any dangers and damages to the ceramic hob and **please contact the supplier.**

## 8. TECHNICAL SPECIFICATIONS

Cooktop model	TRC604
Cooking Zones	4 Zones
Supply Voltage	220-240V~
Installed Electric Power	6000W(230V~)
Product Size L×W×H (mm)	590X520X47
Building-in Dimensions A×B (mm)	560X490

Weight and Dimensions are approximate. Because we continually strive to improve our products, we may change specifications and designs without prior notice.

## 9. DISPOSAL



This appliance requires special waste disposal. For further information regarding the treatment, recovery and recycling of this product please contact your local council household waste disposal service or the store of purchase.

The packaging materials are recyclable.



## 10. CUSTOMER CARE

- Please be advised that without the proof of purchase, your warranty may not be valid, **keep the receipt**.

For your convenience, please record:

STORE NAME/CONTACT DETAILS: .....

PURCHASE DATE: .....

PRODUCT MODEL N: .....

PRODUCT SERIAL N: .....

- The warranty will be voided, if not installed by a licensed professional.

For your own protection, please record installer's details:

Installer's Trade Name: .....

Trade Licence N: .....

Date of Installation: .....

Installation Receipt: .....

For further information on the appliance, service, spare parts or to obtain dimension and installation information, please contact our customer service or visit website.

***Please have above information and documents on hands before contacting customer service***

**Phone: 1300 615 001**

**Email: [info@trinityappliances.com.au](mailto:info@trinityappliances.com.au)**

**Web: [trinityappliances.com.au](http://trinityappliances.com.au)**

