



Comfort, Aesthetics and Reliability

User Manual

60 cm Built-in Electric Oven

Model Code: TRO6010SS; TRO6010BK

Please read this manual carefully before using, and keep it for future reference.

INSTRUCTION MANUAL

60cm Built-in Electric Oven

Models: TRO6010SS; TRO6010BK

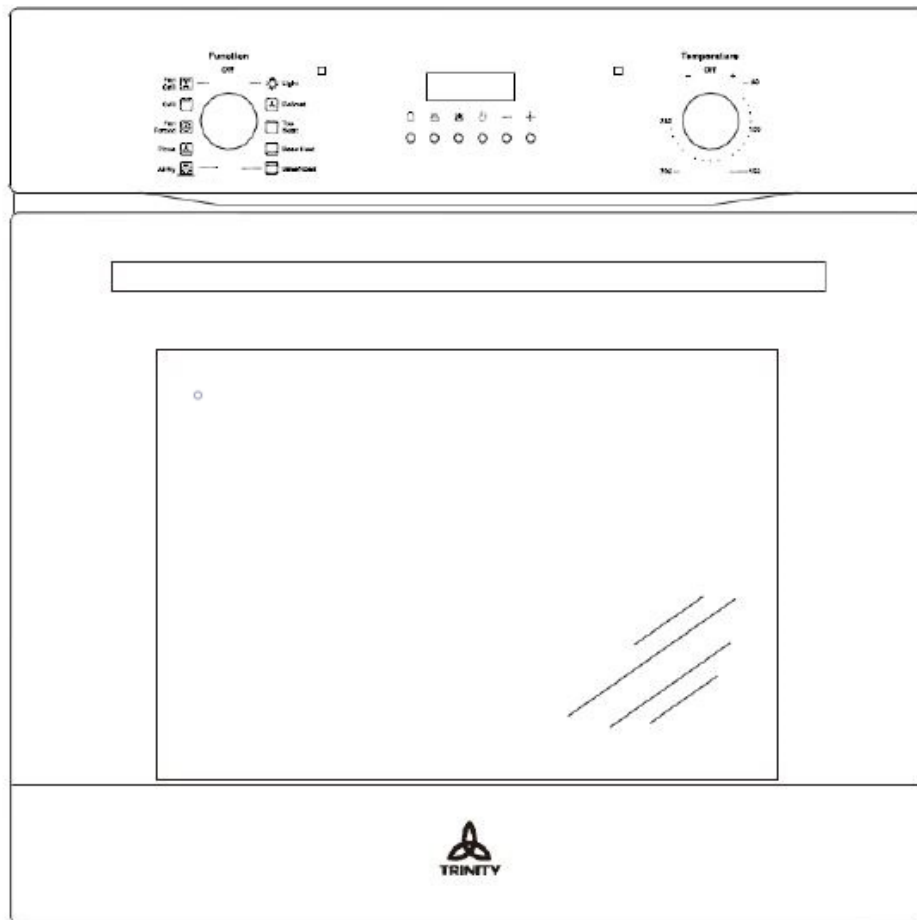

CONTENTS

1	PACKAGE.....	4
1.1	IMPORTANT - CHECK FOR ANY DAMAGE OR MARKS	4
1.2	HANDLING.....	4
1.3	BEFORE USING YOUR NEW APPLIANCE.....	4
2	SAFETY WARNINGS.....	5
2.1	IMPORTANT INFORMATION	5
2.2	GENERAL WARNINGS	5
2.3	INSTALLATION ADVICE.....	5
2.4	USAGE CONDITIONS AND RESTRICTIONS.....	6
2.5	ELECTRICAL SAFETY	7
3	PRODUCT OVERVIEW.....	9
3.1	INTRODUCING THE OVEN	9
4	INSTALLATION.....	12
4.1	PREPARING THE CABINET	12
4.2	FASTENING THE OVEN.....	13
4.3	ELECTRICAL CONNECTION.....	14
5	OPERATION	16
5.1	OVEN FUNCTIONS AND OPERATION	16
5.2	PROGRAMMABLE TIMER / DISPLAY.....	19
5.2.1	SELECTING MANUAL OPERATION MODE	19
5.2.2	SETTING THE TIME OF DAY.....	19
5.2.3	SETTING THE MINUTE MINDER	19
5.3	SETTINGS THE COOKING DURATION TIME	20
5.4	DELAYED COOKING / SETTING THE START AND END OF COOKING TIME	20
5.5	FIRST TIME USE OVEN.....	21
5.6	NORMAL USE	21
5.7	ENERGY SAVING TIPS.....	22
6	COOKING GUIDELINES	23
6.1	SELECTION RECOMMENDATIONS	23
7	CLEANING AND MAINTENANCE	26
7.1	KEEP YOUR OVEN IN SHAPE.....	26
7.2	STEAM CLEANING	26
7.3	REPLACING OVEN LAMP	27
7.4	DISASSEMBLING/ASSEMBLING OVEN DOOR	27
7.5	CLEANING OVEN GLASS	28
8	TROUBLESHOOTING.....	29
9	TECHNICAL SPECIFICATIONS	31
10	DISPOSAL.....	32
11	CUSTOMER CARE	33

1 PACKAGE

1.1 IMPORTANT - CHECK FOR ANY DAMAGE OR MARKS

Please thoroughly inspect your goods **at the delivery time**, if you notice any damage to your goods:

- Please notify the delivery team at the time of delivery and **do NOT accept damaged product**.
- Please notify us immediately as the problem can be instantly solved and damaged product return to the courier office.

When you open the package and find the appliance is damaged or marked, you must report it within 24 hours. Do not install or connect the item, keep the package as original, if you wish to claim for damage/marks under the manufacturer's warranty. This does not affect your statutory rights.

Evidence of damage will be required.

1.2 HANDLING

- Do not use the door and/or handle to carry or move the appliance.
- Carry out the movement and transportation in the original packaging.
- Pay maximum attention to the appliance while loading/unloading and handling.
- Make sure that the packaging is securely closed during handling and transportation.
- Protect from external factors (such as humidity, water, etc.) that may damage the packaging.
- Be careful not to damage the appliance due to bumps, crashes, drops, etc. while handling and transporting and not to break or deform it during operation.

1.3 BEFORE USING YOUR NEW APPLIANCE

- Read this guide, taking special note of the 'Safety Warnings' section.
- Remove any protective film that may still be on your appliance.
- This instruction manual has been prepared jointly for multiple models. Some of the specifications explained in the manual, may not be included in your appliance. Pay attention to the explanations with illustrations while reading the manual.

NOTE:

This instruction manual has been prepared jointly for multiple models. Some of the specifications explained in the manual, may be slightly different or not be included in your appliance. Pay attention to the explanations with illustrations while reading the manual.

2 SAFETY WARNINGS

2.1 IMPORTANT INFORMATION

Read this manual thoroughly before you start using the appliance.

The safety precautions instructions reduce the risk of fire, electric shock and injury when correctly complied to.

Please take notice of all warnings, follow the instructions, basic precautions and accident prevention measures when using this appliance.

NOTE: *This appliance should be installed by a licensed electrician or warranty will be voided.*

2.2 GENERAL WARNINGS

- Cooking process shall always be supervised.
- Never try to put out the fire with water. Only shut down the device circuit and then cover the flame with a cover or a fire blanket.
- Do not heat closed cans and glass jars. The pressure may lead jars to explode.
- Be careful when using alcohol in your foods. Alcohol will evaporate at high temperatures and may catch fire to cause a fire if it comes in contact with hot surfaces.
- After each use, check if the unit is turned off.
- If the appliance is faulty or has a visible damage, do not operate the appliance.
- Do not touch the plug with wet hands. Do not pull the cord to plug off, always hold the plug.
- The packaging materials are dangerous for children. Keep packaging materials away from the reach of children.

2.3 INSTALLATION ADVICE

- Make sure that furniture and housing are able to withstand high temperatures from the use of the oven.
- Vinyl and laminate kitchen furniture are prone to heat damage or being discoloured from the heat. We assume no liability from any damaged cause by this appliance being installed in close proximity to the materials or furniture that cannot handle the heat. Make sure the room has plenty of ventilation as heat, steam and moisture will be produced from the oven while in use. If the oven will be used for long periods of time, extra ventilation is needed.
- Make sure that no cables come into contact with where the oven can get hot.
- Do not install oven next to soft furnishings or curtains.
- If power cord is damaged, it must be replaced immediately by a qualified electrician to avoid hazard.

2.4 USAGE CONDITIONS AND RESTRICTIONS

- Supervision over children is to ensure that they do not play with the appliance. Never allow them to use, play with or crawl inside the appliance. Cleaning and maintenance must not be done by children.
- This appliance is not to be used by persons (including children) with reduced physical, sensory or mental capabilities, or lack of experience and knowledge, unless they are being supervised or been given instructions on how to use of the appliance in a safe way and understand the hazards with using this appliance incorrectly.
- Never leave the oven unattended while in use, oils and fats may catch fire while cooking.
- Only for indoor domestic use only. It is not to be used for industrial or commercial use.
- Do not use this product for anything other than its intended purpose, and only use it as described in this manual. Do not attempt to alter or modify this appliance.
- In use, the door window may become hot. Make sure not to touch it or that no children or pets come into contact with the door window.
- Damage or malfunction caused from foreign objects is not covered by your warranty to the appliance.
- This oven is not to be used by an external timer or a complete separate control system.
- Make sure you turn off the oven before you commence cleaning.
- Do not use the oven for heating an area or drying clothes.
- Make sure you do not use the oven if any part has been damaged or does not work correctly. It must only be repaired by a qualified technician. An incorrect repair could expose you to risk of electric shock, fire or injury. If you continue to use the product in such a condition it could cause a fire or electrocution.
- Incorrect use can result in property damage, injury or death. We assume no liability for misuse of the appliance or noncompliance with these instructions.
- Oven door must stay closed when using the grill function. Oven handle is not a towel drier. Do not hang towels, etc. on the oven handle during use.
- While cooking, don't place pans, oven trays, plates or aluminium foils, other cookware on the base of your oven. The accumulated heat may damage the base of the oven.
- Make sure to always place items on shelves provided. Do not place the baking paper on the base of the oven. Never use it at higher oven temperatures than the maximum usage temperature indicated on your baking paper. To lower the risk of touching the oven heater elements, remove excess parts of the baking paper that hang over from the accessory or container.
- Place the oven shelves and a tray correctly on the wire racks. The shelve or tray shall be between two rails and balanced.
- Make sure when removing anything from the oven, always use an oven mitt.

- Do not use aluminium anywhere within the oven grills or to cover the grill pan or wrap heated items under the grill. Aluminium foil is highly reflective and can cause damage to the grill element.
- Do not lift or move appliance by the oven door or handle, this may cause damage to the appliance or injure the person attempting to lift appliance.
- Clean the oven on a regular basis so oils and fats do not build up, as this can cause a fire risk. Do not use harsh cleaners or metal scrapers to clean door glass. Do not steam clean anything that's part of the oven, when cleaning oven make sure no part of it is immersed in water or other liquid.
- Do not touch hot surfaces. The heating element and other parts inside the oven become extremely hot. Make sure you take care when handling food and to always use oven mitts. Keep children well away from the oven.
- When opening the oven door, make sure to avoid contact with hot parts of the oven and steam.
- There is a danger of fire when you leave items inside the oven for too long, especially if an item is left for the next time use.
- Do not use the appliance with its front door glass removed or broken.
- When the door is open, do not place any heavy object on the door or allow children to sit on it. You may cause the oven to overturn or the door hinges to be damaged.
- Do not use abrasive cleaners or sharp metal scrapers to clean the glass as the scratches that may occur on the surface of the door glass may cause the glass to break.
- This appliance is for household use only, don't use it outdoors.

2.5 ELECTRICAL SAFETY

- Plug the appliance in a grounded socket protected by a fuse conforming to the values specified in the technical specifications chart.
- Have a licensed electrician set grounding equipment and install the oven. The warranty will be voided and manufacture won't be responsible for the damages occurred due to improper installation and using the product without grounding according to the local regulations.
- The circuit breaker switches of the oven shall be placed so that end user can reach them when the oven is installed.
- The power supply cord (the cord with plug) shall not contact the hot parts of the appliance.
- The rear surface of the oven also heats up when the oven is operated. Electrical connections shall not touch the rear surface, otherwise the connections may be damaged.
- Do not tighten the connecting cables to the oven door and do not run them over hot surfaces. If the cord melts, this may cause the oven to short circuit and even a fire.
- Unplug the unit during installation, service, maintenance, cleaning and repair.
- Cut off all supply circuit connections before accessing the terminals.

- If the power supply cable is damaged, it must be replaced by its manufacturer or authorized technical service or any other personnel qualified at the same level. Appliance is equipped with a type "Y" cord cable.
- Make sure the plug is inserted firmly into wall socket to avoid sparks.
- Do not use steam cleaners for cleaning the appliance, otherwise electric shock may occur.
- An omnipolar switch capable to disconnect power supply to the appliance is required for installation. Disconnection from power supply shall be provided with a switch or an integrated fuse, circuit breaker installed on fixed power supply according to wiring regulations and building code.

3 PRODUCT OVERVIEW

3.1 INTRODUCING THE OVEN

- The oven large capacity offers the option of cooking on multi shelves at the same time and cooking large meals which would not be possible in a traditional oven.
- The first time you use your appliance, heat the empty oven with its door closed at the temperature 180C for a half an hour. Make sure that the room is ventilated before switching the oven off and opening the oven door. The appliance may emit a slightly unpleasant odour caused by protective substances burning away.
- Never put objects directly on the bottom of the oven or cover it with aluminium foil as this will prevent the enamel coating from being damaged. Place cookware on the oven racks.

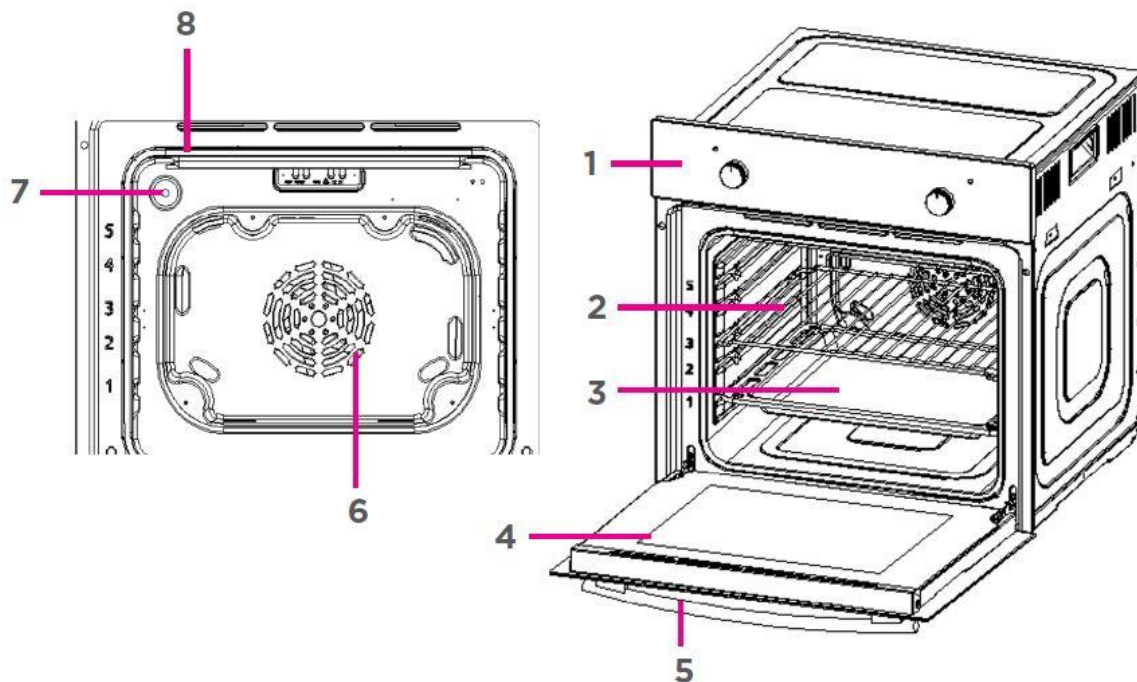

1. Control Panel
2. Wire Shelf
3. Tray
4. Door

5. Handle
6. Fan Motor (behind steel place)
7. Lamp
8. Grill Heating Element

OPTIONAL ACCESSORIES:

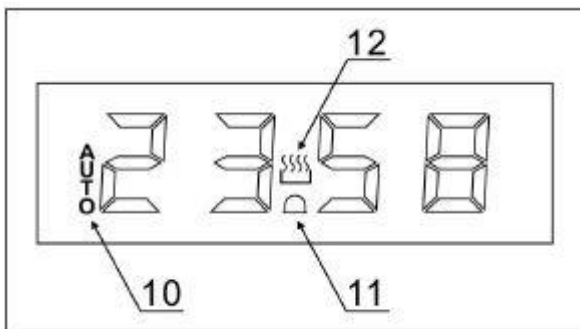
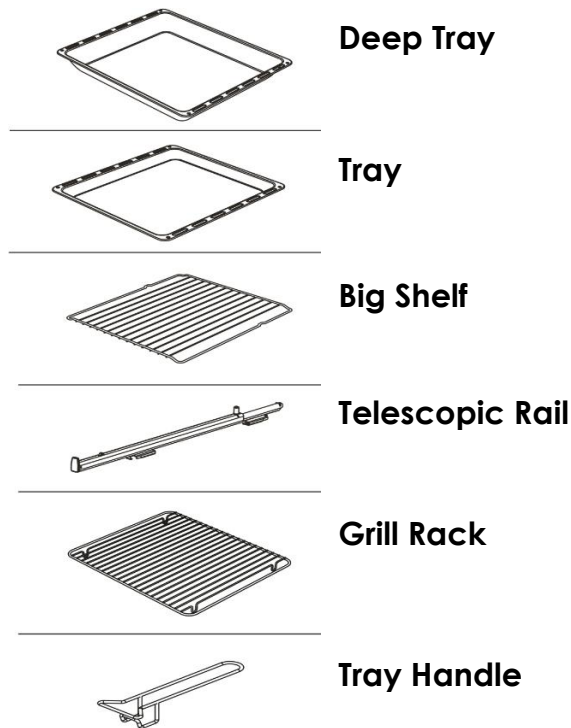

OVEN PROGRAMMER/TIMER DISPLAY

- 10 - Auto Function Symbol
- 11 - Minute Minder Symbol
- 12 - Manual Operation Symbol

CONTROL PANEL:

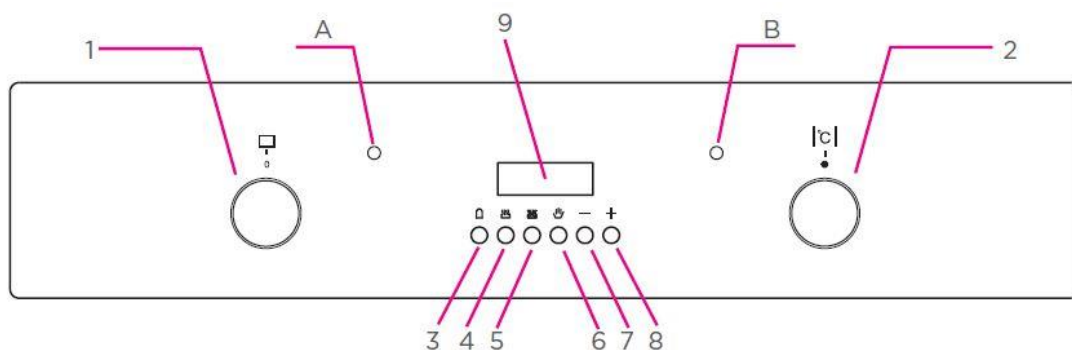

- 1. Oven Function Selector
- 2. Temperature controller
- 3. Minute Minder Button
- 4. Duration Button
- 5. End Cook Button
- 6. Manual Operation Button
- 7. Decrease Button
- 8. Increase Button
- 9. LED Display

FUNCTION SELECTOR

There are 10 options when deciding what to use:

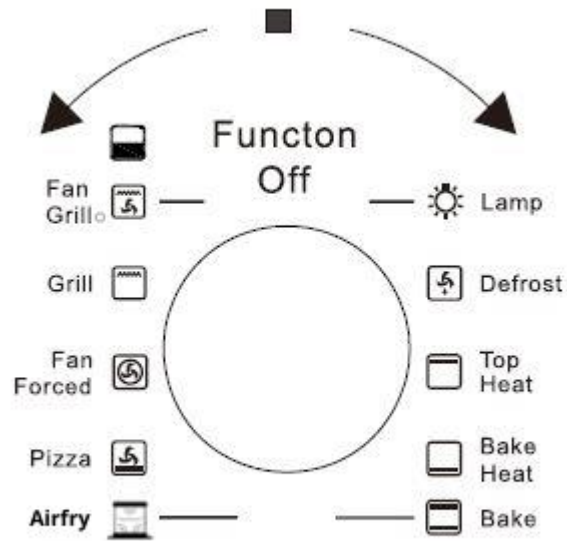

TEMPERATURE SELECTOR

Turn the temperature regulator knob clockwise to set the required temperature. The oven function must be set alongside temperature selection.

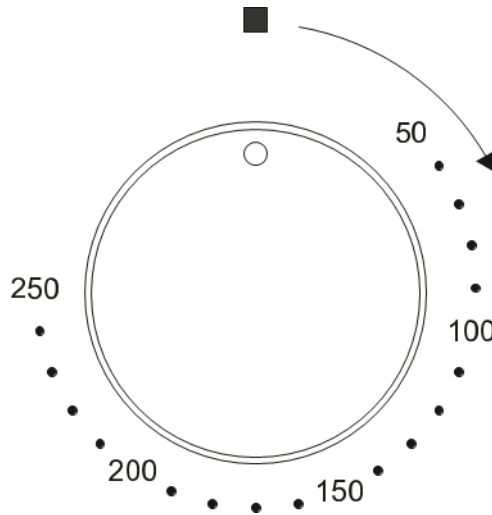

4 INSTALLATION

WARNING: Check for any damage on the product before installing it. Do not have product installed if it's damaged. Damaged products pose danger for your safety.

The power supply to the appliance must be cut off before any adjustments or maintenance work is done on it.

4.1 PREPARING THE CABINET

To ensure the proper working order of the built-in oven, the cabinet must be of a suitable size.

The sizes of the cabinet for installing the oven under a benchtop or in a column unit are shown below.

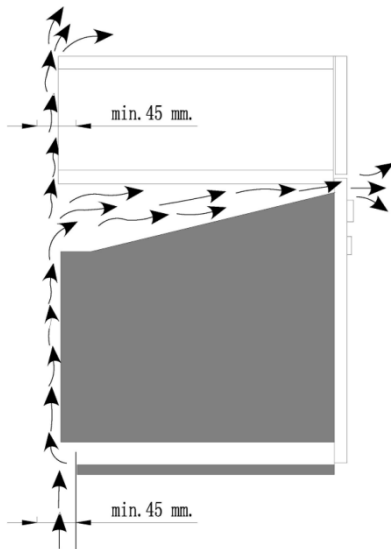

To provide adequate ventilation, there must be appropriate ventilation openings in the front bottom and the top part of the cabinet. Cooling fan shall take extra steam out and prevent outer surfaces of appliance from overheating during operation of oven. This is a necessary condition for better appliance operation and better cooking. Cooling fan shall continue operation after cooking is finished. Fan shall automatically stop after cooling is completed. A clearance must be left behind the enclosure where you'll place the appliance for efficient and good operation. This clearance shouldn't be ignored as it's required for ventilation system of the appliance to operate.

The unit panels next to the cooker must be heat resistant. In the case of veneered wood units, glues must be resistant to a temperature of 120°C.

Do not install the product next to refrigerators or coolers. The heat emitted by the product increases the energy consumption of cooling devices.

In accordance with safety standards, once the appliance has been mounted, there must be no possible contact with electrical parts. Any protective parts must be secured so that they can only be removed with the use of tools.

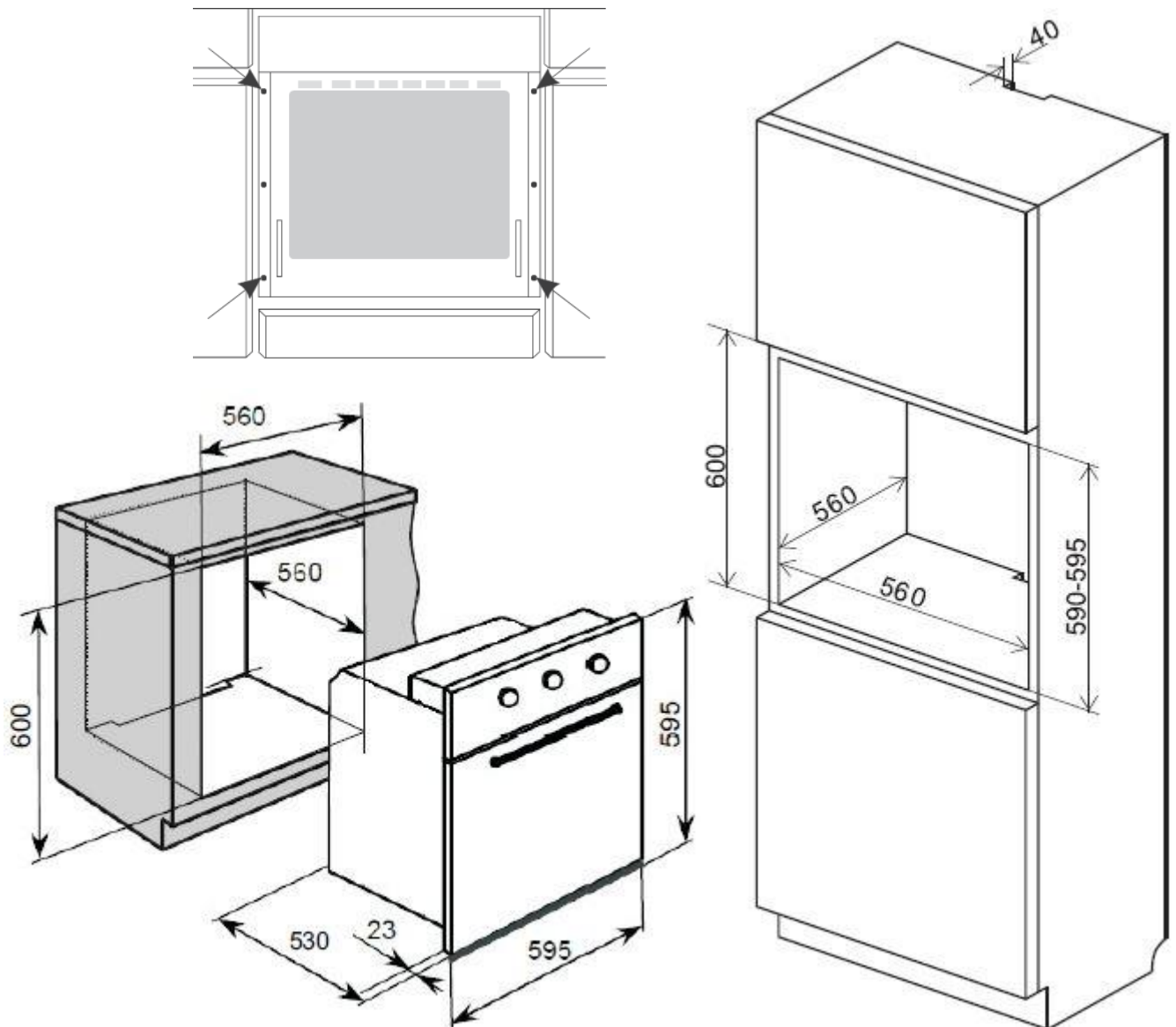

Product Dimensions	Aperture Dimensions
---------------------------	----------------------------

Height: 595mm	600mm
---------------	-------

Width: 595mm	560mm
--------------	-------

Depth: 530mm	560mm (min)
--------------	-------------

4.2 FASTENING THE OVEN

Do not use door and/or handle to carry or move the product.

- Place the oven into the cabinet with two or more people. Ensure that oven's frame and front edge of the furniture match uniformly.
- Supply cord must NOT be under the oven, squeeze in between oven and furniture or bend.

- Open the oven door and fasten the oven to the cabinet using four screws “A” as shown in below diagram. Screws mustn't be over tightened. Otherwise, screw sockets might be worn.
- Check that oven doesn't move after mounting. If oven isn't mounted in accordance with instructions, there is a risk of tilt over during operation.

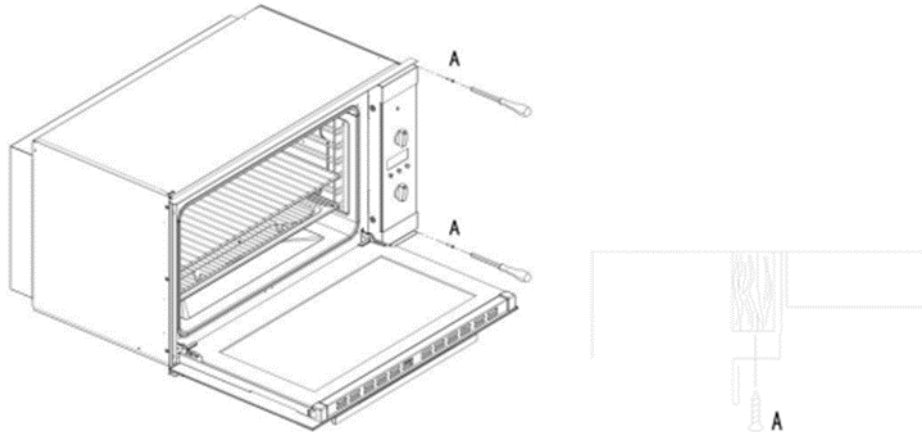

4.3 ELECTRICAL CONNECTION

IMPORTANT!

This appliance should be installed and connected to the power supply by a licensed electrician or warranty void.

The connection must be in accordance with the current versions of the following:

- AS/NZS 3000 Wiring Rules
- Electricity Safety Regulations 2010
- The installation instructions within this user manual

Wiring requirements:

The oven **MUST** be installed in compliance with:

- Wiring connections in AS/NZS 3000 Wiring Rules.
- Local regulations, building codes, other statutory regulations and standards.
- Make sure supply voltage corresponds with your mains supply voltage.
- This appliance must be earthed.

Connection to the power supply:

Below connection information is for reference only.

The oven comes pre-terminated with the fitted cord and appropriately rated plug.

- The socket-outlet fitted connection to the final sub-circuit in the fixed wiring that is intended to supply this appliance is preferable. If the power point is fitted it must be accessible with the appliance installed.

The oven supplied with the fitted cord and no plug fitted.

- The junction connection using appropriately rated terminals and a junction box must be arranged to the final sub-circuit in the fixed wiring that is intended to supply this appliance.

The hard wiring connection:

- Remove terminal cover plate from rear panel of the oven.
- Fit wires through and connect to the appropriate terminals.
- Engage wires into plastic clip. Secure plastic clip.
- Replace cover plate onto rear panel.

Connection Diagram

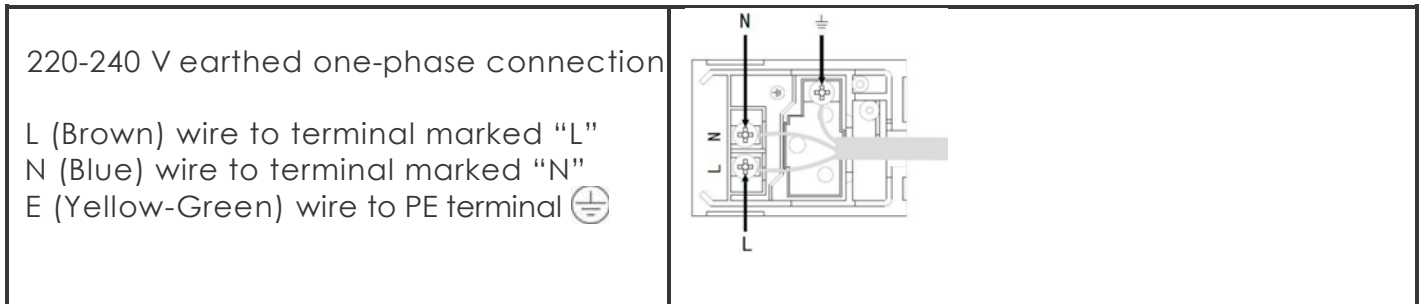

Connecting the electricity supply cable to the mains

- Ovens equipped with a three-pole power supply cable are designed to operate with alternating current at the voltage and frequency indicated on the data plate located on the appliance.
- The Data Plate located on the oven frame behind the door gives information about rating.
- A functional, rated current power switch **MUST** be provided near the appliance in an accessible position (AS/NZS 3000 - Clause 4.7.1).
- Wiring must not be bent or compressed and must be protected against mechanical failure (AS/NZS 3000 - Clause 3.9).
- Disconnection in the fixed wiring must occur in accordance with the AS/NZS 3000 wiring rules.
- The oven **MUST** be properly earthed.
- This oven must be connected with cable of 75°C rating minimum.
- This product has passed the insulation resistance test after manufacture. If the resistance reading is low at installation, it is probably caused by moisture from the atmosphere being absorbed by the elements after the range has been produced. (pass at 0.01 M AS/NZS 3000 Wiring Rules Clause 8.3.6.2).

Connecting to the mains services and commissioning

This appliance must be installed by a licensed electrician, according to all codes and regulations of:

- Electrical supply authorities.
- Building regulations.
- Local government and council authorities.
- AS/NZS 5601.1 (particular attention to clause 6.10.1, including figure 6.3 and subclause 6.10.1.11).
- AS/NZS 3000 (particular attention to clauses 4.7.1 and 3.9)

5 OPERATION

5.1 OVEN FUNCTIONS AND OPERATION

Operation of the oven is controlled by the function knobs, temperature controller and a timer.

- **To set required function turn the knob to the selected position.**

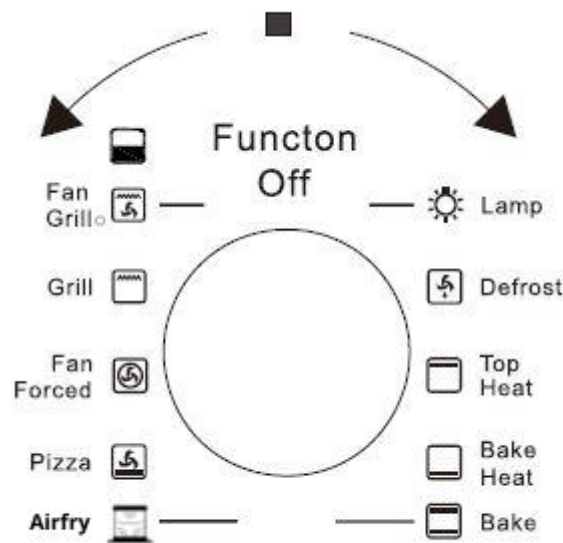

- **Oven switch ON / OFF**





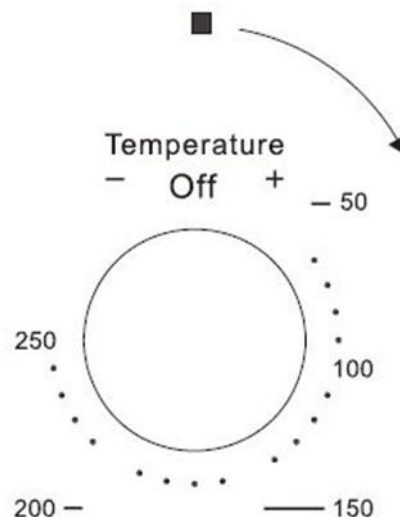

To turn the oven on, the function, temperature and time must be selected.





The oven can be switched off by setting both of the function knobs to "OFF" position.

- **To set required temperature turn the knob to the selected temperature position.**



OVEN FUNCTIONS

Function		Description
 Light	Oven light	Separate light control allows the light to be switched on, even when the oven is not in cooking function, illuminates cavity, useful when cleaning.
 Defrost	Defrosting	Select this function to thaw more delicate foods. In this mode the room temperature air is used. Useful for the gentle defrosting of frozen food. Only the alarm function can be used with the defrost oven function. None of the other timer modes will work with the defrost function.
 Bake/Roast	Conventional oven mode Bottom and top heaters on	The convection mode is recommended for preparing meat-based dishes featuring liquids. It still remains the best cooking mode for dry pastries and fruit in general. When cooking in convection mode, only use one dripping-pan or cooking rack at a time, otherwise the heat distribution will be uneven. Useful for baking and roasting traditional recipes, preparing soufflés and cooking at low temperatures.
 Top Heat	Top Element Only	Useful for final baking from above, warming up pre-cooked food when placed on the second shelf from the top, or for defrosting pastry placed on the first shelf from the bottom.
 Base Heat	Bottom element Only	This setting is ideal when cooking delicate foods, especially pastries that need to rise, because the heat rises from the bottom. Select this program towards the end of cooking time if the lower part of the food needs to be roasted. This function takes a rather longer time to reach higher temperatures in the oven. Use this function towards the end of cooking to reheat or brown the base of baked food such as a cake, quiche or pizza. Useful when final baking from the bottom is needed.
 Fan Forced	Back element with fan on	This method of cooking uses the heat from the circular element distributed by the fan. This fan circulates the hot air around the cavity so the food can be put in different places and still be cooked at the same time. Useful for multi-shelf cooking, reheating cooked foods, pastries and complete oven meals. It will cook at a lower temperature and be faster than baking. The excellent heat distribution makes it possible to use lower temperatures when cooking roasts. This results in less loss of juices, meat which is more tender and a decrease in the loss of weight for the roast. The ventilated mode is especially suited for cooking fish, which can be prepared with the addition of a limited amount of condiments, thus maintaining their flavour.

		and appearance. The ventilated mode can also be used to thaw white or red meat, fish and bread by setting the desired temperature.
 Pizza	Fan and bottom heaters on	This setting heats from the bottom but with heat distributed more evenly. It's an ideal function for pizzas, cakes tarts, quiches and pies, anything requiring a crispy base or moist toppings.
 Airfry	Fan and top heaters on	This setting with a specially designed tray, allows very hot air to circulate around the food quickly and evenly. With little to no oil, food will be healthier and more delicious, crispy outside and juicy inside. There is no need to turn the food during the cooking.
 Grill	Grill	This function uses the inner part of the top element, which directs heat downwards onto the food. Can be used for grilling portions of bacon, toast and meat products such as steak, sausages, chicken and fish. The high, direct grill temperature immediately browns meat, thus stopping juice dispersion and keeping meat more tender. The grill is particularly recommended for cooking dishes requiring a high superficial temperature. Useful for grilling and toasting bread, open sandwiches etc. and browning baked dishes.
 Fan Grill	Fan & Grill	<p>This setting uses the top heat combined with hot air circulation and is suitable where quick browning is required and "sealing" the juices in, such as steaks, hamburgers, some vegetables etc.</p> <p>Useful for grilling thicker cuts of meat such as rolls and roulades, chicken. Lower temperatures can be used than when using the Grill function, as the fan distributes the heat to the food straight away.</p> <p>Can be used for grilling meat products such as steak, sausages, chicken and fish. This will allow the heat to penetrate into the food and helps avoid food surface overcooked.</p>

5.2 PROGRAMMABLE TIMER / DISPLAY

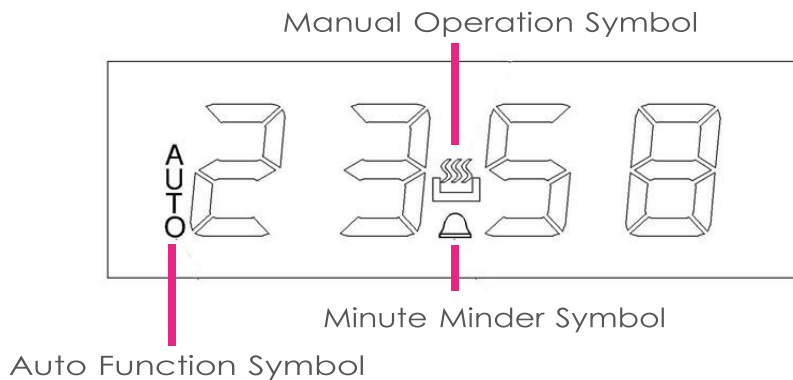

5.2.1 SELECTING MANUAL OPERATION MODE

When your appliance is connected to your mains supply for the first time, the numbers on the timer display will flash. Before you can select a cooking function or set a temperature, you must set the appliance into “Manual Operation Mode”.

- To select manual operation mode, press the “Manual Operation” button on the control panel.

5.2.2 SETTING THE TIME OF DAY

After setting your oven for manual operation, you should also set the time of day.

- After pressing the “manual operation” button, use the “minus” and “plus” buttons to adjust the time that appears in the display. After getting the display to the correct time, release the “minus” and “plus” buttons. After a few seconds the time will fix in the display and you will be able to use your oven.

5.2.3 SETTING THE MINUTE MINDER

You are able to set the minute minder at any time, regardless of whether an oven function has been selected. You can set a period of time using the minute minder function and an alarm will sound when that period of time has elapsed.

- Press the “minute minder” button, the display will show a value of 00:00. Set a period of time that you wish the minute minder to countdown for, by using the “minus” and “plus” buttons.
- Once the display has your countdown time, let go of the “minus” and “plus” buttons. The minute minder symbol should appear on the display.
- When a countdown is set, it is possible to shorten or lengthen the time but using the “minus” and “plus” buttons.
- An alarm will sound when the countdown time has over. The alarm can be silenced by pressing the “minute minder” button.

IMPORTANT: *The oven will continue to heat once the alarm has been silenced, if you have finished cooking, then turn the oven function selector and thermostat control knob to 0/OFF position.*

5.3 SETTINGS THE COOKING DURATION TIME

This function will allow you to set a countdown time similar to the minute minder function. However, the oven will no longer continue to heat, once the countdown period has elapsed.

- Use the thermostat control knob to set the temperature that you require. The manual operation symbol will appear on the display.
- Use the oven function selector knob to select the mode of cooking that you require.
- It is then possible to set the duration of the cooking time that you require.
- Press the “duration” button and the display will show a value 00:00. Set the period of time that you wish the duration function countdown for, by using the “minus” and “plus” buttons.
- Once the display has got to the countdown you want, let go of the “minus” and “plus” buttons. The countdown will start and the sign AUTO will appear on the display.
- Once a countdown time has been set, it is possible to shorten or lengthen the time by using the “minus” and “plus” buttons.
- An alarm will sound when the countdown time has elapsed and the oven will switch off. The word AUTO will flash and heating symbol disappear.
- The alarm can be silenced by pressing the “duration” button.
- You will need to return the oven to manual operation mode, once the duration function has been used. To do this should press the “manual operation” button, the word AUTO will disappear from the display and the manual operation symbol will appear instead.

IMPORTANT: *If you do not turn the thermostat control knob and oven function selector knob to 0/OFF, then the appliance will continue to operate as soon as you press the “Manual Operation” button.*

5.4 DELAYED COOKING / SETTING THE START AND END OF COOKING TIME

This function will allow you to set a time in the future that the oven switches on at and a time that the oven will switch off at.

- Use the thermostat control knob to set the temperature that you require. The manual operation will appear on the display.
- Use the oven function selector knob to select the mode of cooking that you require.
- Press the “cooking duration” button and the display will show a value of 00:00. Set the period of time that you wish to cook for, by using the “minus” and “plus” buttons. The sign AUTO will appear on the timer display.
- Immediately press the “end of cooking” button and the timer display will show the value 00:00. Set the time of day that you want the oven to switch off at, using the “minus” and “plus” buttons.
- The oven’s timer will calculate what time it needs to switch on at, so that your food will cook for the length of time that you have selected. It will automatically switch itself on, once it reaches the time of day that you set previously.
- When the time of day reaches the end of the cooking time that you set, the oven will switch off and alarm will sound. The sign AUTO will flash and the heating symbol

will disappear. The alarm can be silenced by pressing the “end of cooking” or “cooking duration” button.

- You will need to return the oven to manual operation mode, once the start and end time function has been used. To do this you should press the “manual operation” button, the word AUTO will disappear from the display and the manual operation symbol will appear instead.

WARNING!

- ***For personal safety and to avoid any potential fire risk, do not program the timer and then leave the oven unattended.***
- ***For food safety reasons, do not leave easily spoilt foods in the oven for too long when using the timer.***

When baking, we do not recommend programming the oven for a delayed start as the cake mixture may dry out and the raising agent may lose their effectiveness.

Example: *if the oven operation has to be finished at 12:05 and shall last 1hr30min, both times have to be set respectively: “END OF COOKING” for 12:05; and “COOKING DURATION” for 1.30 so the timer will switch on the oven at 10:35 and turn off the oven at 12:05.*

5.5 FIRST TIME USE OVEN

Here are the things you must do at first use of your:

1. Remove labels or accessories attached inside the oven remove protective film on front side of the appliance.
2. Remove dust and package residues by wiping inside of the oven with a damp cloth. Inside of oven must be empty. Plug the cable of appliance into the electrical socket.
3. Set the thermostat button to the temperature 180 °C and run the oven for about half an hour with its door closed. Meanwhile a slight smoke and smell might occur and that's a normal.
4. Wipe inside of the oven with a slightly warm water with detergent after it becomes cold and then dry with a clean cloth. Now you can use your oven.

5.6 NORMAL USE

1. Adjust thermostat button and temperature at which you want to cook to start cooking.
2. You can set cooking time to any desired time by using the timer. Timer will turn off heaters when time expired.
3. Cooling system of the appliance will continue to operate after cooking is completed. Do not cut the power of appliance in this situation which is required for appliance to cool down. System will shut down after cooling is completed.

5.7 ENERGY SAVING TIPS

Following details will help use your product ecologically and economically:

- Use dark coloured and enamel containers that conduct the heat better in the oven.
- Do not open the oven door frequently while cooking. The oven will not lose heat.
- Try not to cook multiple dishes simultaneously in the oven. You may cook at the same time multiple dishes.
- Turn off the oven a few minutes before the expiration time of cooking. In this case, do not open the oven door.
- Defrost the frozen food before cooking.

6 COOKING GUIDELINES

6.1 SELECTION RECOMMENDATIONS

The following table shows the information of food types and identified their cooking values. Cooking times can vary depending on the network voltage, quality of raw food to be cooked, quantity and temperature. Dishes to cook by using these values might not appeal to your taste. You can set various values for obtaining different tastes and results appealing to your taste by making tests.

Preheating

According to the specific recipes, the oven often recommended to be preheated before placing the food into it. If the oven must be preheated the " Turbo back heater and fan " mode is an energy safe option. Once the food has been placed in the oven. The most appropriate cooking mode can then be selected.

Using the grill

The multi-function oven offers you three different grilling modes. Use the "Grill " setting for grilling in perfect mode small portions like toasted sandwiches, hotdogs, etc., to perfection. The " Maxi Grill " position is the best for grilling foods rapidly.

For a better distribution of heat, not only to brown the surface but also to cook the bottom part, select " Maxi Grill fan forced " function. This mode can also be used for browning foods at the end of the cooking process.

Always use the grill with the oven door closed. This will allow you both to attain excellent results and to save energy. When using any of the three grilling modes, it is recommended that the thermostat knob be turned to the 175°C, as it is the most efficient way to use the grill. When utilizing the grill, place the rack at the lower levels. To catch grease or fat and prevent smoke, place a dripping-pan at the bottom rack level.

Baking pastries

When baking pastries, always place them in the oven after it has been preheated. Make sure you wait until the oven has been preheated thoroughly, the indicator red " E " light will turn off. Do not open the door while the pastry is cooking in order to prevent it from dropping. Batters must not be too runny, as this will result in prolonged cooking times.

Possible issues when baking and optional solutions:

Issue	Solution
Pastry is too dry	Increase the temperature by 10°C and reduce the cooking time.
Pastry dropped	Use less liquid or lower the temperature by 10°C.

Pastry is too dark on top	Place it on a lower rack, lower the temperature, and increase the cooking time.
Cooked well on the inside but sticky on the outside	Use less liquid, lower the temperature, and increase the cooking time.
The pastry sticks to the pan	Grease the pan well and sprinkle it with a dusting of flour.
Used more than one level and pastry not all at the same cooking point	Use a lower temperature setting. It is not necessary to remove the food from all the racks at the same time.

Cooking Pizza

When cooking pizza use of the fan forced modes is common: Lower, upper heating element with fan or Turbo back heater fan forced

- Preheat the oven for about 7-10 minutes.
- Use a light aluminium pizza pan, placing it on the shelved supplied with the oven. If the tray is used, this will extend the cooking time, making it difficult to get a crispy crust.
- Do not open the oven door frequently while the pizza is cooking.
- If the pizza has a lot of toppings, it is recommended that the cheese be placed on top halfway through the cooking process.

Cooking Fish and Meat

Meat must weigh at least 1 Kg in order to prevent it from drying out. When cooking white meat, fowl and fish, use low temperature settings (150°C-220°C). For red meat that should be well done on the outside while tender and juicy in the inside, it is a good idea to start with a high temperature setting (200°C-220°C) for a short time, then turn the oven down afterwards. In general, the larger the roast, the lower the temperature setting to allow cook the food from inside. Place the meat on the centre of the rack and place the tray/dripping pan beneath it to catch the fat.

Make sure that the shelves and trays are properly inserted and in the centre of the oven. If you would like to increase the amount of heat from below, use the low rack heights. For savory roasts, especially duck and wild game meats, dress the meat with lard or bacon on the top. Cooking times may vary according to the nature of the foods, its homogeneity and volume.

Cooking in oven tips:

Fault	Cause	Solution
The upper crust is dark and the lower part too pale	Not enough heat from the bottom	Use the natural convection position Use deeper baking tins Lower the temperature Put the food on a lower shelf
The lower part is dark and the upper crust too pale	Excessive heat from the bottom	Use the natural convection position Use lower side tins Lower the temperature Put the food on a higher shelf
The outside is over cooked and the inside not cooked enough	Too high temperature	Lower the temperature and increase cooking time
The outside is too dry even though of the right color	Too low temperature	Increase the temperature and reduce cooking time.

7 CLEANING AND MAINTENANCE

7.1 KEEP YOUR OVEN IN SHAPE

- Don't clean the appliance when it still hot! The inside and external surface of the oven should preferably be cleaned by damp cloth when it is cooled down.
- If you use your oven for an extended period of time, condensation may form. Dry it using a soft cloth.
- Do not clean inner parts, panel, trays and other parts of the product with hard tools such as bristle brush, wire wool or knife. Do not use abrasive, scratching materials or detergent.
- Rinse after wiping the parts at inner parts of the product with soapy cloth, then dry thoroughly with a soft cloth.
- Clean glass surfaces with special glass cleaning material.
- Do not clean your oven with steam cleaners.
- Never use combustibles like acid, thinner and gas while cleaning your product.
- Do not wash any part of the product in dishwasher.
- Use dish-washing liquid, warm water and a soft cloth for stubborn dirt, then dry off the area you have just cleaned with a dry cloth or a paper towel.
- There is a rubber seal surrounding the oven opening which guarantees its perfect functioning. Check the condition of this seal on a regular basis. If necessary, clean it and avoid using abrasive products or objects to do so. Should it become damaged, please contact your nearest After-sales Service Centre. We recommend you avoid using the oven until it has been repaired.
- Never line the oven bottom with aluminium foil, as the consequent accumulation of heat could compromise the cooking and damage the enamel.

7.2 STEAM CLEANING

1. Pour 250ml of water (1 glass) into a bowl placed in the oven on the first level from the bottom.
2. Close the oven door.
3. Set the temperature knob to 50°C, and the function knob to bottom heater position.
4. Heat the oven chamber for approximately 30 minutes.
5. Open the oven door, wipe the chamber inside with a cloth or sponge and wash using warm water with washing liquid.

Caution! Possible moisture or water resides under the cooker can result from steam cleaning. After cleaning the oven chamber wipe it dry.

7.3 REPLACING OVEN LAMP

WARNING: First disconnect the power of appliance and ensure that appliance is cold. Remove the power plug from electrical socket or disconnect the power supply by tripping off circuit breaker (opening circuit) or removing fuse.

To avoid the possibility of an electric shock ensure that the appliance is switched off before replacing the bulb.

1. Set all control knobs to the position off "0" and disconnect the mains power.
2. Unscrew and wash the lamp cover and then wipe it dry.
3. Unscrew the light bulb from the socket, replace the bulb with a new high temperature bulb (300°C) of the following specification:
 - voltage 230 V
 - power 25 W
 - **thread E14**
4. Screw the bulb in, making sure it is properly inserted into the ceramic socket.
5. Screw in the lamp cover.

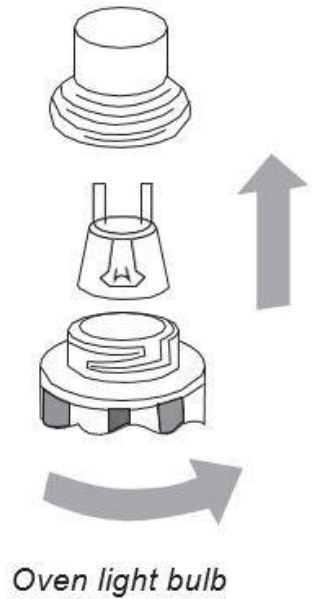

7.4 DISASSEMBLING/ASSEMBLING OVEN DOOR

To make it easier to clean the inside of your oven, the oven door can be removed, by proceeding as follows:

Removing the doors

- a. The oven door should be fully open.

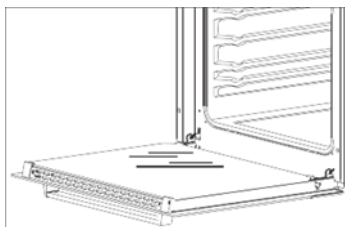

- b. The latch hinges completely lifted.

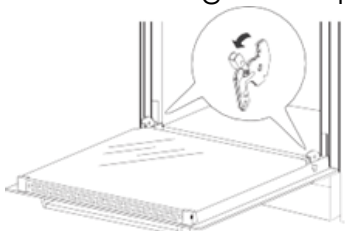

- c. Gently close the oven door until you hear the sound of engagement, once they reach a clamping position, with both hands holding the door and continue to push, pull up at the same time so that the hinge bolt removed from the oven.

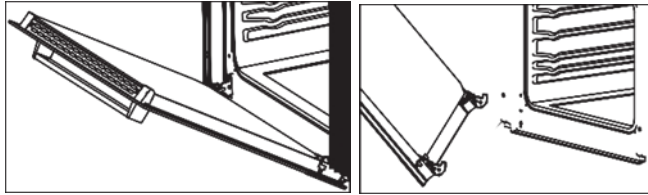

- d. After cleaning, the hinge needs to be aligned with the oven door latch; push gently until they clip into place.
- e. Push the latch down to its original position with the oven door fully open.

7.5 CLEANING OVEN GLASS

Remove the inner glass panel

- a. Glass door has two plastic fixing blocks. Use a slotted screwdriver to insert into the hole of the plastic fixing block and gently pry it.

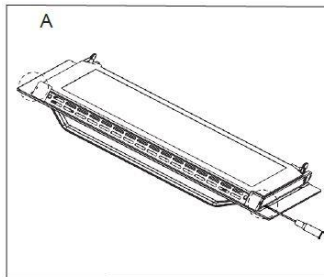

- b. Remove the fixing blocks and the top end of the plastic ventilation grid.

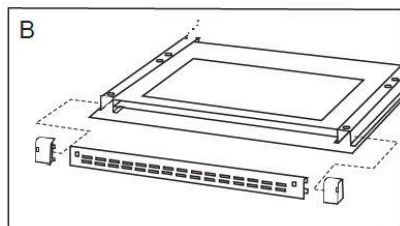

- c. Pull out the inner glass from beneath the plastic fixing blocks. After cleaning, insert the inner glass, followed by the plastic fixing blocks and the grid and refit the screws. The door can now be re-installed.

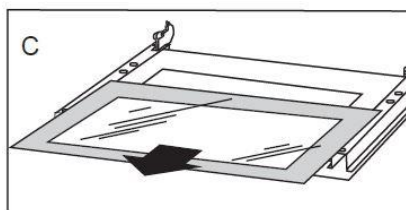

IMPORTANT: Remember where the glass panel been removed from and reassemble the door correctly. Do not mix the glasses or rearrange the order.

8 TROUBLESHOOTING

You may solve the problems you may encounter with your product by checking the following points.

Check the table below and try out the suggestions.

Problem	Possible Cause	What to Do
Oven does not operate	Power supply not available	Check for power supply. Check household fuse box. Replace the fuse or reset the circuit breaker.
	Oven is not in "Operation" mode	Check that a cooking function and temperature has been selected.
Oven stops during cooking	Plug comes out from the wall socket	Re-install the plug into wall socket.
Turns off during cooking	Too long continuous operation.	Let the oven cool down after long cooking cycles. Check for any abnormal sound from the cooling fan assembly.
	Cooling fan not operating	Listen the sound from the cooling fan.
	Oven not installed in a location with good ventilation	Make sure clearances specified in operating instructions are maintained.
	More than one plugs in a wall socket	Use only one plug for each wall socket.
The grill and top oven element is not working, or cuts out for long periods of time during use.	Prevent overheating	Allow oven to cool down for 2 hours. Once its temperature normal, check whether appliance is working properly.
Outer surface of the oven gets very hot during operation.	Oven not installed in a location with good ventilation	Make sure clearances specified in operating instructions are maintained.
Oven door is not opening properly	Food residues jammed between the door and internal cavity	Clean the oven well and try to re-open the door.
Internal light is dim or does not operate	Foreign object covering the lamp during cooking	Clean internal surface of the oven and check again. Make sure light bulb is not loose, try to move and tighten it.
	Lamp might be failed	Replace with a lamp of same specifications.
	No proper grounding	

Electric shock when touching the oven	Ungrounded wall socket is used	Make sure power supply is grounded properly.
Water dripping	Water or steam may generate under certain conditions depending on the water content of food being cooked. This is not a fault of the appliance	Let the oven cool down and then wipe dry with a cloth. Don't leave food in oven after finished cooking, especially with closed door and the oven has been switched off.
Steam coming out from a gaps of the oven door		
Moisture condensation remaining inside the oven		
The cooling fan continues to operate after cooking is finished	The fan operates for a certain period for ventilation of internal cavity of the oven	A cooling fan is fitted inside the appliance to cool inside and external surface down. This is not a fault of the appliance but normal operation function.
Oven does not heat	Oven door is open	Close the door and restart.
	Oven controls not correctly adjusted	Read the section regarding operation of the oven and reset the oven.
	Fuse tripped or circuit breaker turned off	Replace the fuse or reset the circuit breaker. If this is repeating frequently, call an electrician.
Smoke coming out during operation	When operating the oven for the first time	Smoke comes out from the heaters. This is not a fault. After 2-3 cycles, there will be no more smoke.
	Food on heater	Let the oven to cool down and clean food residues from the ground of the oven and surface of upper heater.
When operating the oven burnt or plastic odour coming out	Plastic or other not heat resistant material are being used	Use suitable, heat resistant accessories.
Oven does not cook well	Oven door is opened frequently during cooking	Do not open oven door frequently, if the food you are cooking does not require turning. If you open the door frequently internal temperature drops and therefore cooking result will be influenced.

9 TECHNICAL SPECIFICATIONS

Electric oven size	73 litres
Oven size	595mm x 595mm x 530mm (WxDxH)
Weight	Approx. 28kg
Voltage rating	220-240V~ 50/60 Hz
Power rating	max.2.9kw
Energy rating	A

Note: The values provided with the appliance or its accompanying documents are laboratory readings in accordance with the respective standards. These values may differ depending on the use and ambient conditions. Figures in this guide are schematic and may not be exactly match your product. We continually strive to improve our products. The specifications and designs might be changed without notice.

10DISPOSAL



This appliance requires special waste disposal. For further information regarding the treatment, recovery and recycling of this product please contact your local council, household waste disposal service or the store where you purchased it.

The packaging materials are recyclable.



11 CUSTOMER CARE

- Please be advised that without the proof of purchase, your warranty may not be valid, **keep the receipt**.

For your convenience, please record:

STORE NAME/CONTACT DETAILS:

PURCHASE DATE:

PRODUCT MODEL N:

PRODUCT SERIAL N:

- The warranty will be voided, if not installed by a licensed professional.

For your own protection, please record installer's details:

Installer's Trade Name:

Trade Licence N:

Date of Installation:

Installation Receipt:

For further information on the appliance, service, spare parts or to obtain dimension and installation information, please contact our customer service or visit website.

Please have above information and documents on hands before contacting customer service

Phone: 1300 615 001

Email: info@trinityappliances.com.au

Web: trinityappliances.com.au

